

CATALOG

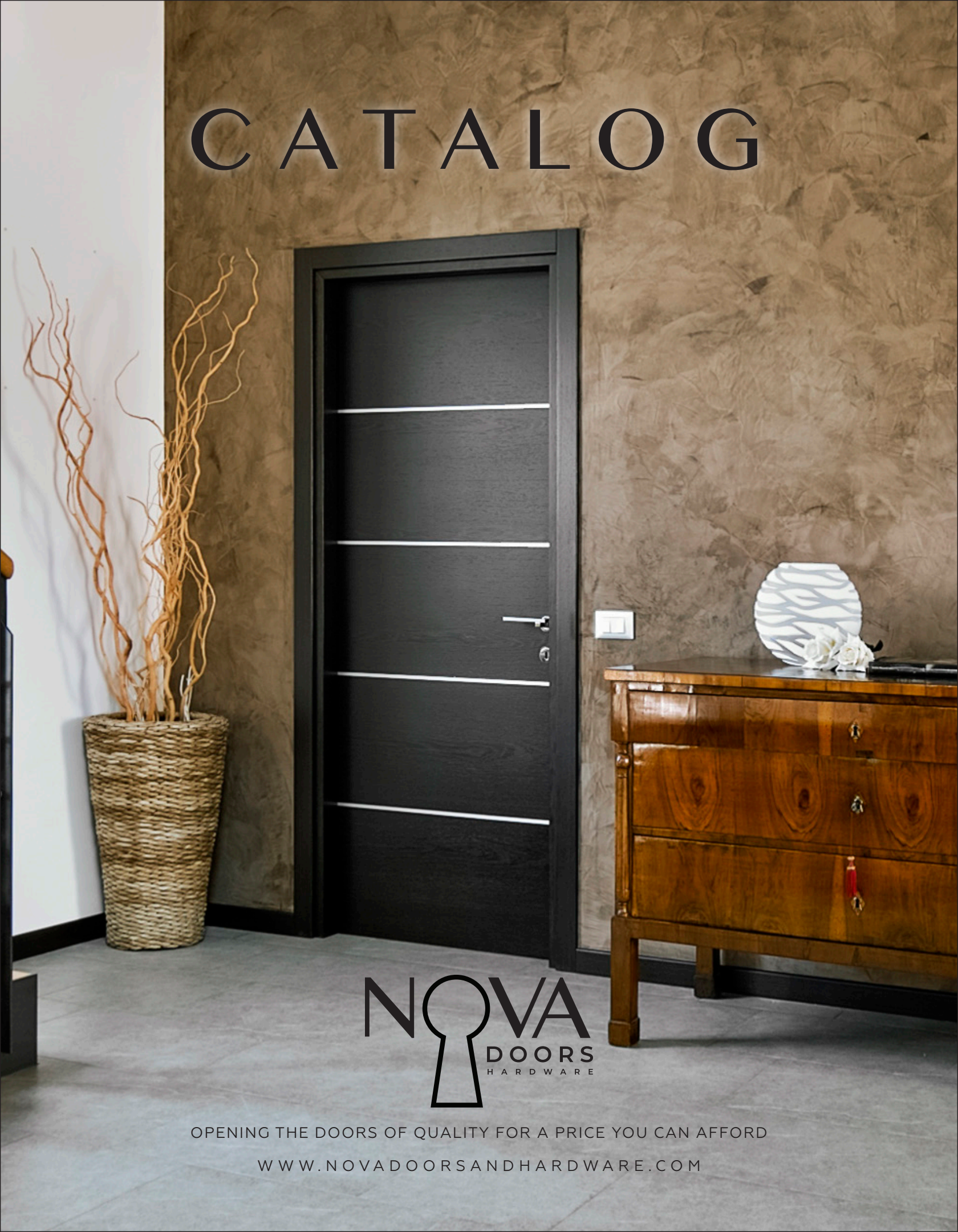

NOVA
DOORS
HARDWARE

OPENING THE DOORS OF QUALITY FOR A PRICE YOU CAN AFFORD

WWW.NOVADOORSANDHARDWARE.COM



Italia Series	04
Italia Flush Series	06
Italia Vetro Series	10
Italia Stile Series	14
Triplex Series	18
Stile Series	22
Glam Series	26
High Gloss Laminated Series	28
Laminated Series	30
Inox Series Entry Doors	36
Wrought Iron Entry Doors	40
Sliding, Bi-Fold & Pivot Closets	46
Hardware	54
Door Construction Info	57
Installation Info	60



ABOUT US

Opening the doors of quality for a price you can afford.

Nova Doors and Hardware was established in 2007. Starting in a small, 300-square foot showroom, we have grown into a multinational operation through our values of offering excellent products and superior, personalized customer service. Manufacturing mainly in the United States with supplemental facilities in Europe and Asia, we couple genuine innovation with value to offer a sought-after catalog of entry solutions. Headquartered in the heart of New Jersey, our extensive line is offered in most locales in the nation and throughout Canada.

As a manufacturer, we extend a higher level of service to our customers through bespoke designs, customized sizing, and infinite pre-hung services. Driven to provide positive customer experience and value, each product undergoes scrutiny in two phases: before packaging and again before shipment, ensuring the delivery of quality merchandise.

Nova Doors and Hardware is driven by a customer-centric model. We strive to offer the market top-quality product that is paired with like service. Our confidence that we do just that is underlined by industry-leading three-year interior door warranties and our lifetime promise that is given with each piece of door hardware you purchase.

It is for these reasons the NOVA reputation is envied industry-wide. This reputation is mirrored by our incredible distribution network and is why our brand enjoys high demand by leading home improvement retailers.

It's nice to meet you.

Italia Series Interior Doors

The Italia Interior Door Series offers class and quality in both design and function, with its rich colors and slim, vertical glass insert. Made in Europe and proudly designed and assembled in the USA, its Premium Smart Core construction and PPL finish offer durability and substantial sound dampening benefits. The Italia Series is available in 6 standard widths (18", 24", 28", 30", 32" and 36") and 3 heights (80", 84" and 96").

Available in five luxurious colors, interchangeable glass, optional aluminum edging, myriad design options, and a 3-Year Warranty, making the Italia Series a Nova best seller.

Technical Specifications

Available Colors	Prestige Brown, Light Gray, Swiss Elm, Alaskan White, Premium Wenge
Finish	PPL High Endurance (Renolit - Germany)
Door Construction	Solid Wood Skeleton with High Density Filler (Smart Core) Sound Proof Insulation (see page 53 for details)
Door Slab Height	80, 84 and 96 inches
Door Slab Width (exact)	17-7/8", 23-7/8", 27-7/8", 29-7/8", 31-7/8", 35-7/8"
Door Thickness	1-3/4 inches (45mm)
Door Slab Weight	Medium Size - 70 Pounds
Jamb Width	Telescopic 4" - 5-1/2" X 86" and 100" (extension available for over 5-1/2")
Door Molding Width	3" - L-Shaped, 86" and 100" Length, 5/8" Thick
Custom Size	Any Width and Height Up to 96 Inches
Custom Color	Over 50 Colors Available for Special Order (Renolit Catalogs)
Sliding Jamb	Flat Jamb 4"-5 1/2", 3/4" thick (Bypass/Sliding) Extensions Available for over 5 1/2"
Pocket Jamb	3 Split Jamb 1 Flat Jamb (Per Single Door), 3/4" thick
Floor Baseboard	4" X 96" X 5/8" All Stock colors Available
Astragal	Double Door Astragal (Covers Gap Between the 2 doors)
2 Sided Panel	3/8" X 36" X 96" For Custom Sliding/Bifold/Pivot closet Doors
Extension	2 1/2" X 5/8" X 86" and 100" (Used For Walls over 5 1/2" Thick)
Stripe Finish	Brushed Anodized, Shine Gold Anodized, Brushed Gold Anodized, Brilliant Anodized, Pre-Painted Matte Black, Pre Painted Brilliant Black
Warranty	Leading 3-Year Structural Warranty

Available Glass Options



Black



Clear



Frosted



White

Features:

- Premium Solid Core Construction
- Five Finish Options: Prestige Brown, Light Gray, Swiss Elm, White, Premium Wenge
- Premium PPL Laminated Finish
- Glass Options Available
- Six Stripe Finishes Available for Select Models
- Proudly Designed and Assembled in the USA and Overseas
- 3-Year Warranty

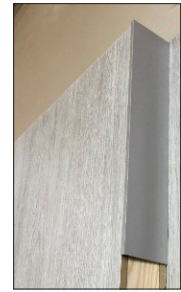

Optional Aluminum Edging



ITALIA LIGHT GREY



ITALIA SWISS ELM



ITALIA PRESTIGE BROWN



ITALIA PREMIUM WENGE



ITALIA ALASKAN WHITE



Italia Flush Series Interior Doors

The Italia Flush Series strikes a perfect balance between modern and classical design. With five different PPL finish color options, and 10 different design options, the Italia Flush Series is highly customizable to find the perfect fit for you and your home.

It also offers all the same construction benefits as all Italia series doors, such as Premium Smart Core construction, availability in 6 standard widths and 80", 84" or 96" heights, 45mm thickness, design and assembly in the USA. Available colors include Alaskan White, Light Gray, Prestige Brown, Swiss Elm and Premium Wenge



Optional Aluminum Edging

Stripe Finishes for Select Models



Brushed Anodized

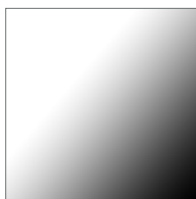

Brilliant Anodized



Brushed Gold Anodized



Shine Gold Anodized



Pre Painted Matte Black



Pre Painted Brilliant Black



ITALIA FLUSH 01 PB



ITALIA FLUSH 02 PB



ITALIA FLUSH 03 PB



ITALIA FLUSH 04 PB



ITALIA FLUSH 05 PB



ITALIA FLUSH 06 PB



ITALIA FLUSH 07 PB



ITALIA FLUSH 08 PB



ITALIA FLUSH 09 PB



ITALIA FLUSH 10 PB

ITALIA FLUSH SERIES INTERIOR DOORS



ITALIA FLUSH 01 SE



ITALIA FLUSH 02 SE



ITALIA FLUSH 03 SE



ITALIA FLUSH 04 SE



ITALIA FLUSH 05 SE



ITALIA FLUSH 06 SE



ITALIA FLUSH 07 SE



ITALIA FLUSH 08 SE



ITALIA FLUSH 09 SE



ITALIA FLUSH 10 SE





ITALIA FLUSH 01 LG



ITALIA FLUSH 02 LG



ITALIA FLUSH 03 LG



ITALIA FLUSH 04 LG



ITALIA FLUSH 05 LG



ITALIA FLUSH 06 LG



ITALIA FLUSH 07 LG



ITALIA FLUSH 08 LG



ITALIA FLUSH 09 LG



ITALIA FLUSH 10 LG



ITALIA FLUSH 01 PW



ITALIA FLUSH 02 PW



ITALIA FLUSH 03 PW



ITALIA FLUSH 04 PW



ITALIA FLUSH 05 PW



ITALIA FLUSH 06 PW



ITALIA FLUSH 07 PW



ITALIA FLUSH 08 PW



ITALIA FLUSH 09 PW



ITALIA FLUSH 10 PW



ITALIA FLUSH 01 AW



ITALIA FLUSH 02 AW



ITALIA FLUSH 03 AW



ITALIA FLUSH 04 AW



ITALIA FLUSH 05 AW



ITALIA FLUSH 06 AW



ITALIA FLUSH 07 AW



ITALIA FLUSH 08 AW



ITALIA FLUSH 09 AW



ITALIA FLUSH 10 AW

Italia Vetro Series Interior Doors

The Italia Vetro Series offers a clean, modern, yet comfortable feel for your office and home. Completely and proudly made and assembled in the US, the Vetro series offers 11 model options which are extremely customizable to your taste and style.

Available in the same five luxurious colors, our unique design options incorporate top quality materials, such as triplex glass available in white, clear and frosted, crafted with expertise. All components, including 80", 84" and 96" stiles are always kept in stock, so the lead time for your Italia Vetro is kept to a minimum.

Stripe Finishes for Select Models



Brushed Anodized

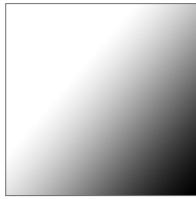

Brilliant Anodized



Brushed Gold Anodized



Shine Gold Anodized



Pre Painted Matte Black



Pre Painted Brilliant Black

Available Glass Options



Black



Clear



Frosted



White

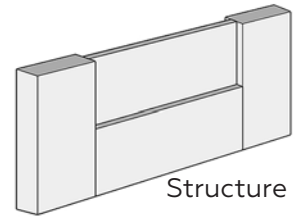

Structure





VETRO 01 LG



VETRO 1H LG



VETRO 2HC LG



VETRO 2H LG



VETRO 3H LG



VETRO 1 LITE LG



VETRO 2 LITE LG



VETRO 3 LITE LG



VETRO 4 LITE LG



VETRO 5 LITE LG



VETRO 6 LITE LG



VETRO 01 PB



VETRO 1H PB



VETRO 2HC PB



VETRO 2H PB



VETRO 3H PB



VETRO 1 LITE PB



VETRO 2 LITE PB



VETRO 3 LITE PB



VETRO 4 LITE PB



VETRO 5 LITE PB



VETRO 6 LITE PB



VETRO 01 SE



VETRO 1H SE



VETRO 2HC SE



VETRO 2H SE



VETRO 3H SE



VETRO 1 LITE SE



VETRO 2 LITE SE



VETRO 3 LITE SE



VETRO 4 LITE SE



VETRO 5 LITE SE



VETRO 6 LITE SE





VETRO 01 PW



VETRO 1H PW



VETRO 2HC PW



VETRO 2H PW



VETRO 3H PW



VETRO 1 LITE PW



VETRO 2 LITE PW



VETRO 3 LITE PW



VETRO 4 LITE PW



VETRO 5 LITE PW



VETRO 6 LITE PW



VETRO 01 AW



VETRO 1H AW



VETRO 2HC AW



VETRO 2H AW



VETRO 3H AW



VETRO 1 LITE AW



VETRO 2 LITE AW



VETRO 3 LITE AW



VETRO 4 LITE AW



VETRO 5 LITE AW



VETRO 6 LITE AW

Italia Stile Series Interior Doors

The Italia Flush Series strikes a perfect balance between modern and classical design. With five different PPL finish color options, and 10 different design options, the Italia Flush Series is highly customizable to find the perfect fit for you and your home.

It also offers all the same construction benefits as all Italia series doors, such as Premium Smart Core construction, availability in 6 standard widths and 80", 84" or 96" heights, 45mm thickness, design and assembly in the USA. Available colors include Alaskan White, Light Gray, Prestige Brown, Swiss Elm and Premium Wenge



Optional Aluminum Edging

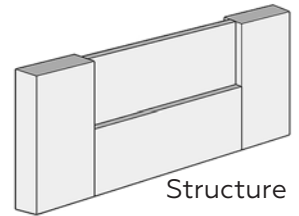

Structure

Stripe Finishes for Select Models



Brushed Anodized

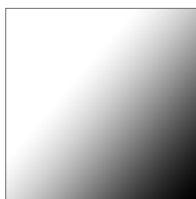

Brilliant Anodized



Brushed Gold Anodized



Shine Gold Anodized



Pre Painted Matte Black



Pre Painted Brilliant Black



ITALIA STILE 01 LG



ITALIA STILE 1H LG



ITALIA STILE 2HC LG



ITALIA STILE 2H LG



ITALIA STILE 3H LG



ITALIA STILE 1L LG



ITALIA STILE 2L LG



ITALIA STILE 3L LG



ITALIA STILE 4L LG



ITALIA STILE 5L LG



ITALIA STILE 6L LG

ITALIA STILE SERIES INTERIOR DOORS



ITALIA STILE 01 PB



ITALIA STILE 1H PB



ITALIA STILE 2HC PB



ITALIA STILE 2H PB



ITALIA STILE 3H PB



ITALIA STILE 1L PB



ITALIA STILE 2L PB



ITALIA STILE 3L PB



ITALIA STILE 4L PB



ITALIA STILE 5L PB



ITALIA STILE 6L PB





ITALLIA STILE 01 SE



ITALLIA STILE 1H SE



ITALLIA STILE 2HC SE



ITALLIA STILE 2H SE



ITALLIA STILE 3H SE



ITALLIA STILE 1L SE



ITALLIA STILE 2L SE



ITALLIA STILE 3L SE



ITALLIA STILE 4L SE



ITALLIA STILE 5L SE



ITALLIA STILE 6L SE



ITALIA VETRO SERIES INTERIOR DOORS



ITALIA STILE 01 PW



ITALIA STILE 1H PW



ITALIA STILE 2HC PW



ITALIA STILE 2H PW



ITALIA STILE 3H PW



ITALIA STILE 1L PW



ITALIA STILE 2L PW



ITALIA STILE 3L PW



ITALIA STILE 4L PW



ITALIA STILE 5L PW



ITALIA STILE 6L PW



ITALIA STILE 01 AW



ITALIA STILE 1H AW



ITALIA STILE 2HC AW



ITALIA STILE 2H AW



ITALIA STILE 3H AW



ITALIA STILE 1L AW



ITALIA STILE 2L AW



ITALIA STILE 3L AW



ITALIA STILE 4L AW



ITALIA STILE 5L AW



ITALIA STILE 6L AW

Triplex Series Interior Doors

One of the most popular Nova Doors and Hardware interior door ranges, the Triplex Series maintains an open, flowing atmosphere, even with the door closed. These modern interior doors are constructed of solid wood, MDF, and fused triplex frosted glass. All 80" Triplex doors are available in 6 standard widths and are made in Europe. The 84" and 96" Triplex Series also have many customizable design options, and each door is made in America and assembled by hand, with the highest expertise and care.

Features:

- Sleek White UV Lacquered Paint Finish
- Glass Options Available
- Six Stripe Finishes Available for Select Models
- Proudly Designed and Assembled in the USA And Overseas
- 3-Year Warranty

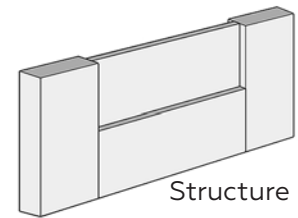

Technical Specifications

Available Colors	White
Finish	Laminated Soft White Finish
Door Construction	Solid Pine Wood and Glass (see page 53 for details)
Door Slab Height	80, 84 and 96 inches
Door Slab Width (exact)	17-7/8", 23-7/8", 27-7/8", 29-7/8", 31-7/8", 35-7/8"
Door Thickness	1-3/4 inches (45mm)
Door Slab Weight	Medium Size - 90 Pounds
Jamb Width	Telescopic 4"-5 1/2" X 86" and 100" (Extensions Available for over 5 1/2")
Door Molding Width	3" - L-Shaped 86" and 100" Length 5/8" Thick
Custom Size	Any Width up to 38" and Height Up to 96" Inches
Custom Color	Over 200 Colors Available for Special Order (PROUD Catalog)
Sliding Jamb	Flat Jamb 4"-5 1/2", 3/4" thick (Bypass/Sliding) Extensions Available for over 5 1/2"
Pocket Jamb	3 Split Jambs 1 Flat Jamb (Per Single Door), 3/4" thick
Astragal	Double Door Astragal (Covers Gap Between the 2 doors)
Extension	2 1/2" X 5/8" X 86" and 100" (Used For Walls over 5 1/2" Thick)
Warranty	Leading 3-Year Structural Warranty

Stripe Finishes for Select Models



Brushed Anodized

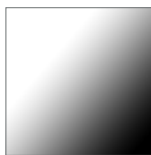

Brilliant Anodized

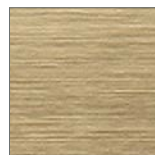

Brushed Gold Anodized



Shine Gold Anodized



Pre Painted Matte Black



Pre Painted Brilliant Black

Available Glass Options



Black



Clear



Frosted

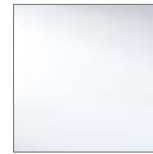

White

TRIPLEX SERIES LAMINATED INTERIOR DOORS



TRIPLEX-001 WHITE



TRIPLEX-002 WHITE



TRIPLEX-003 WHITE



TRIPLEX-004 WHITE



TRIPLEX-005 WHITE



TRIPLEX-006 WHITE



TRIPLEX-007 WHITE



TRIPLEX-008 WHITE



TRIPLEX-009 WHITE



TRIPLEX-012 WHITE





TRIPLEX-013 WHITE



TRIPLEX-015 WHITE



TRIPLEX-017 WHITE



TRIPLEX-018 WHITE



TRIPLEX-020 WHITE



TRIPLEX-021 WHITE



TRIPLEX-022 WHITE



TRIPLEX-023 WHITE



TRIPLEX-024 WHITE

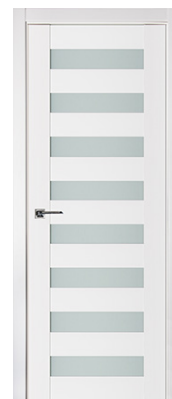

TRIPLEX-025 WHITE

TRIPLEX SERIES INTERIOR DOORS



TRIPLEX-029 WHITE



TRIPLEX-035 WHITE



TRIPLEX-036 WHITE



TRIPLEX-040 WHITE



TRIPLEX-054 WHITE



TRIPLEX-056 WHITE



TRIPLEX-057 WHITE



TRIPLEX-058 WHITE



TRIPLEX-059 WHITE



Stile Series Interior Doors

The Stile Series offers over 10 design options. With slim, vertical frames defining the edges of the door's design, and available panels in 2.5", 5", and 10", this creates a central, eye-catching canvas for geometrical design innovation. Thin, metallic striping accents offer subtle shadowed effects on the surface of the door. Easily one of Nova Door's most unique and customizable options, the Stile Series offers a high quality feel and gliding swing.

Features:

- Laminated Soft White Finish
- Stripe Colors Available
- Proudly Designed and Assembled in the USA And Overseas (DOM)
- 3-Year Warranty

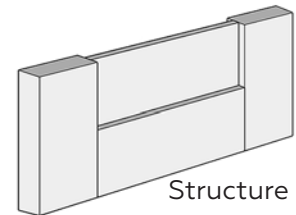

Technical Specifications

Available Colors	White
Finish	Laminated Soft White Finish
Door Construction	Solid Pine Wood with Solid MDF Core
Door Slab Height	80, 84 and 96 inches
Door Slab Width (exact)	17-7/8", 23-7/8", 27-7/8", 29-7/8", 31-7/8", 35-7/8"
Door Thickness	1-3/4 inches (45mm)
Door Slab Weight	Medium Size - 70 Pounds
Jamb Width	Telescopic 4"-5 1/2" X 86" and 100", 3/4" thick Extensions Available for over 5 1/2"
Door Molding Width	3" - L-Shaped 86" and 100" Length 5/8" Thick
Custom Size	Any Width up to 44" and Height Up to 96" Inches
Custom Color	Over 200 Colors Available for Special Order (PROUD Catalog)
Sliding Jamb	Flat Jamb 4"-5 1/2", 3/4" thick (Bypass/Sliding) Extensions Available for over 5 1/2"
Pocket Jamb	3 Split Jambs 1 Flat Jamb (Per Single Door), 3/4" thick
Astragal	Double Door Astragal (Covers Gap Between the 2 doors)
Extension	2 1/2" X 5/8" X 86" and 100" (Used For Walls over 5 1/2" Thick)
Warranty	Leading 3-Year Structural Warranty

Stripe Finishes for Select Models



Brushed
Anodized

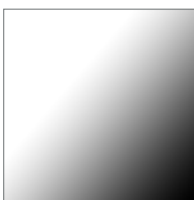

Brilliant
Anodized



Brushed Gold
Anodized



Shine Gold
Anodized



Pre Painted
Matte Black



Pre Painted
Brilliant Black

STILE SERIES INTERIOR DOORS



STILE-001 WHITE



STILE-002 WHITE



STILE-003 WHITE



STILE-004 WHITE



STILE-005 WHITE



STILE-006 WHITE



STILE-007 WHITE



STILE-008 WHITE



STILE-009 WHITE



STILE-012 WHITE





STILE-013 WHITE



STILE-015 WHITE



STILE-017 WHITE



STILE-020 WHITE



STILE-021 WHITE



STILE-022 WHITE



STILE-023 WHITE



STILE-024 WHITE



STILE-025 WHITE



STILE-029 WHITE





STILE-032 WHITE



STILE-035 WHITE



STILE-036 WHITE



STILE-039 WHITE



STILE-040 WHITE



STILE-041 WHITE



STILE-043 WHITE



STILE-044 WHITE



STILE-054 WHITE



STILE-059 WHITE

Glam Series Laminated Interior Doors

The Glam Series is the epitome of simplistic, beautiful design. With pure color and shine, this range of interior doors is the apex when it comes to clean, modern design. It is available in all six standard widths with 80", 84" and 96" heights. This Series also offers both a thick honeycomb interior, and the thickest MDF layer available, at 10mm on each side. These features give the Glam Series excellent sound dampening benefits and a very solid feel. The Glam Series demonstrates great versatility with its 10 design options, and is ideal for several hanging options, such as barn door, sliding doors, and pocket doors. With so many options, it's easy to find a single door or a small collection of doors to fit your design preferences and space.

Features:

- Laminated Soft White Finish
- Stripe Colors Available
- 3-Year Warranty

Technical Specifications

Available Colors	White
Finish	Laminated Soft White Finish
Door Construction	Solid Pine Wood with Reinforced Foamed Panel (see page 53 for details)
Door Slab Height	80, 84 and 96 inches
Door Slab Width (exact)	17-7/8", 23-7/8", 27-7/8", 29-7/8", 31-7/8", 35-7/8"
Door Thickness	1-3/4 inches (45mm)
Door Slab Weight	Medium Size - 70 Pounds
Jamb Width	Telescopic 4"-5 1/2" X 86" and 100", 3/4" thick Extensions Available for over 5 1/2"
Door Molding Width	3" - L-Shaped, 86" and 100" Length, 5/8" Thick
Custom Size	Any Width up to 44" and Height Up to 96" Inches
Custom Color	Over 200 Colors Available for Special Order (PROUD Catalog)
Sliding Jamb	Flat Jamb 4"-5 1/2", 3/4" thick (Bypass/Sliding) Extensions Available for over 5 1/2"
Pocket Jamb	3 Split Jambs 1 Flat Jamb (Per Single Door), 3/4" thick
Astragal	Double Door Astragal (Covers Gap Between the 2 doors)
Extension	2 1/2" X 5/8" X 86" and 100" (Used For Walls over 5 1/2" Thick)
Warranty	Leading 3-Year Structural Warranty

Stripe Finishes for Select Models

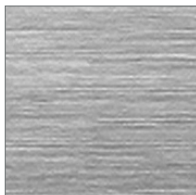

Brushed
Anodized

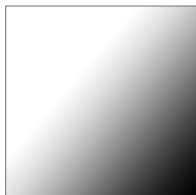

Brilliant
Anodized



Brushed Gold
Anodized



Shine Gold
Anodized



Pre Painted
Matte Black



Pre Painted
Brilliant Black

GLAM SERIES INTERIOR DOORS



GLAM 001



GLAM 002



GLAM 003



GLAM 004



GLAM 005



GLAM 006



GLAM 007



GLAM 008



GLAM 009



GLAM 010



High Gloss Laminated Series

Celebrating modern lines, monochromatic design and engaging with ambient light, the High Gloss Laminated Door Series befits any well-appointed contemporary space. Interior doors, these models are as durable as they are handsome. At the core, the premium door slab is solid and backed by a strong three-year structural warranty.

Smooth and shiny, the white high gloss of the structure is interrupted by horizontal panes of black glass for an opposing, eye-appealing, and modern aesthetic. For the greatest passage of light, the Sydney model boasts wide glass strips while the Ibiza model is more discrete wearing thin black glass panes to allow for more privacy.

Offered in two heights and six slab widths with a 1 ¾" thickness, doors of the High Gloss Laminated Series provide a solution for myriad interiors. As a NOVA door series, many components are customizable for just the right fit.

Features:

- Premium PPL Finish
- High Gloss Enamel Finish
- Black Glass
- 2 Models to Choose From
- 3-Year Structural Warranty

Technical Specifications

Available Colors	High Gloss White
Finish	Smooth High Gloss Finish
Door Construction	Solid Modular MDF and Pine Wood (see page 53 for details)
Door Slab Height	80" and 96"
Door Slab Width (exact)	17-7/8", 23-7/8", 27-7/8", 29-7/8", 31-7/8", 35-7/8"
Door Thickness	1-3/4 inches (45mm)
Door Slab Weight	Heavy Weight - 80 Pounds
Jamb Width	Telescopic 4"-5 1/2" X 86", 3/4" thick Extensions Available for over 5 1/2"
Door Molding Width	3" - L-Shaped 86" 5/8" Thick
Sliding Jamb	Flat Jamb 4"-5 1/2", 3/4" thick (Bypass/Sliding) Extensions Available for over 5 1/2"
Pocket Jamb	3 Split Jambs 1 Flat Jamb (Per Single Door), 3/4" thick
Extension	2 1/2" X 5/8" X 86" (Used For Walls over 5 1/2" Thick)
Warranty	Leading 3-Year Structural Warranty



SYDNEY



IBIZA

Laminated Series Interior Doors

The Nova Laminated Series is one of the more affordable options. However, with over four hundred models and two hundred different finishes in each size, the Laminated Series is one of our best sellers. Its high quality materials and sturdy construction, with MDF over wood, make this a heavy, sturdy door excellent for soundproofing. The endless options of model and finish ensure that you'll find the style and design that speaks to you, with the highest quality material, all at an affordable price.

Features:

- Premium Reinforce Core
- Many Colors available
- PVC Laminated Finish
- Smooth and Textured Finishes
- 3-Year Warranty

Technical Specifications

Available Colors	Aloe Wood, White Wenge, Black Walnut, Pure White, etc
Finish	High Endurance PVC
Door Construction	Solid Pine Wood, MDF Reinforced, Foamed (Sound Proof Insulation) (see page 53 for details)
Door Slab Height	80, 84 and 96 inches
Door Slab Width (exact)	17-7/8", 23-7/8", 27-7/8", 29-7/8", 31-7/8", 35-7/8"
Door Thickness	1-3/4 inches (45mm)
Door Slab Weight	Medium Size - 50 Pound
Jamb Width	Telescopic 4" - 5-1/2" X 86" and 100" (Extensions Available for over 5-1/2")
Door Molding Width	3" - L-Shaped 86" and 100" Length 5/8" Thick
Custom Size	Any Width and Height Up to 96 Inches
Custom Color	Over 200 Colors Available for Special Order (PROUD Catalogs)
Sliding Jamb	Flat Jamb 4"-6", 3/4" thick (Bypass/Sliding) Extensions Available for over 6"
Pocket Jamb	3 Split Jambs 1 Flat Jamb (Per Single Door), 3/4 thick
Floor Baseboard	4" X 96" X 1/2" All Stock colors Available
Astragal	Double Door Astragal (Covers Gap Between the 2 doors)
2 Sided Panel	3/8" X 36" X 96" For Custom Sliding/Bifold/Pivot closet Doors
Extension	2 1/2" X 5/8" X 86" and 100" (Used For Walls over 6" Thick)
Warranty	Leading 3-Year Warranty

LAMINATED SERIES INTERIOR DOORS



HG-008BA



HG-008JO



HG-008KM



HG-008WW



HG-008WD

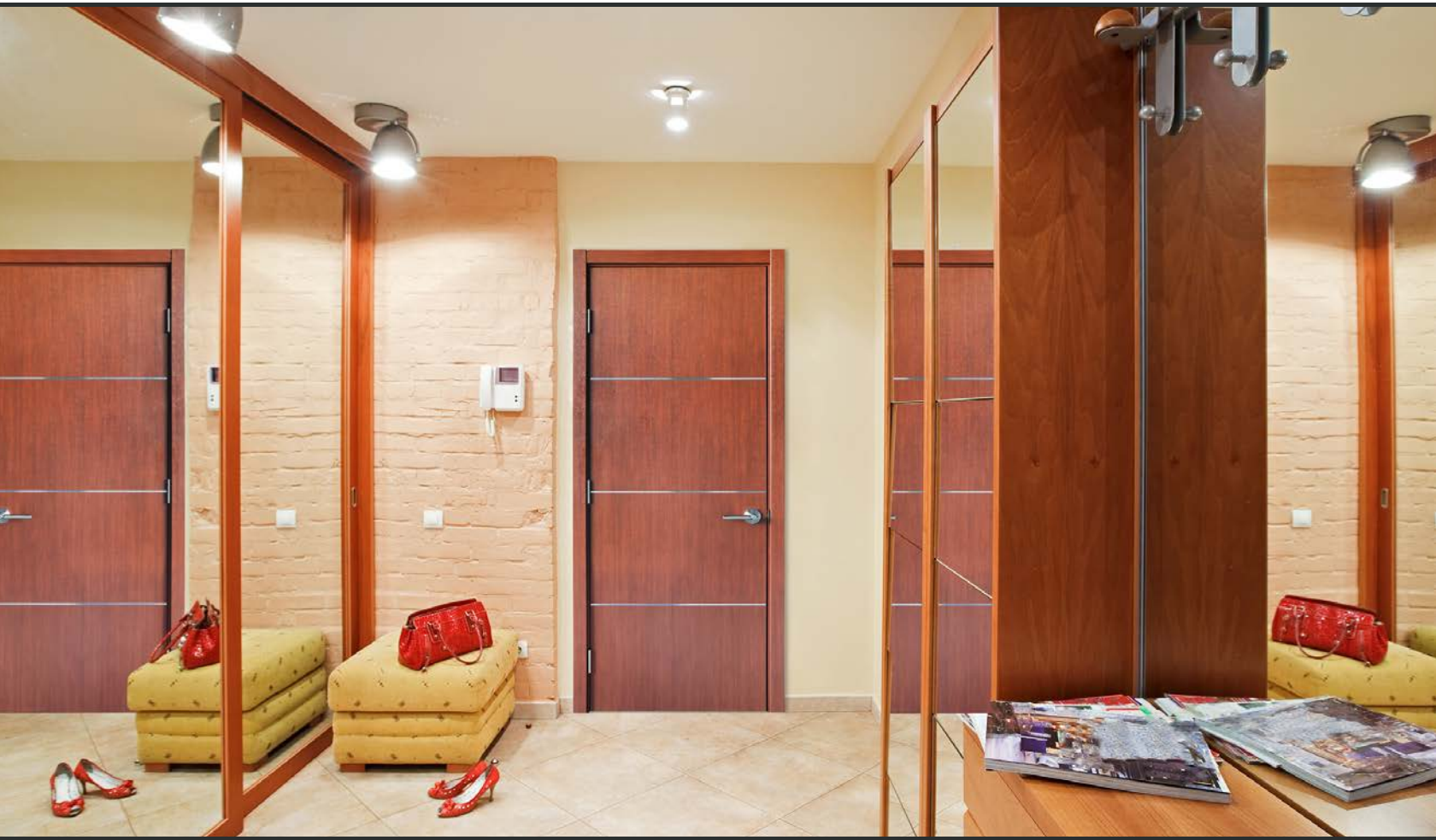

HG-008SA



M-34BW



M-34S



HM-419



1 Lite White Wenge



1 Lite 1H White Wenge



1 Lite 2HC White Wenge



1 Lite 2H White Wenge



1 Lite 3H White Wenge



2 Lite White Wenge



3 Lite White Wenge



4 Lite White Wenge



5 Lite White Wenge



6 Lite White Wenge



HG002V Japan Oak



HG002V Light Aloe



HG002V Dark Aloe



HG002VR Japan Oak



HG002VR Light Aloe



HG002VR Dark Aloe





1 Panel Soft White



2 Panel Soft White



2 Panel Arch Soft White



3 Panel Soft White



GROVE Soft White



OVALO Soft White



SLANT Soft White



5 Panel Soft White



M34 Soft White



GRAFFITI Soft White



Inox Series Entry Doors

Set the stage for your modern home with an entrance to match. The exquisite Inox exterior doors by Nova Doors balance strength and transparency with reflective glass and stainless steel accents. Each design includes your choice for a high-grade finishing color, sidelight or transom installation, and additional trim. The 3.5-inch door is guaranteed to fit all standard American openings and is equipped with security that you can count on as well as 25 year industry leading warranty.

Features:

- Reinforced Stainless Steel Door Edge
- Long Stainless Steel Bar Handle
- 3 Prong High Level Security Lock
- Line Welded Steel Door Frame
- Heavy Duty Welded Ball Bearing Hinges
- Reinforced Structural Steel Frame
- Thermoisolated Core
- Zinc Primer
- 3mm Solid Stainless Steel Protective Sheet
- Powder Coated Finished Steel Surface

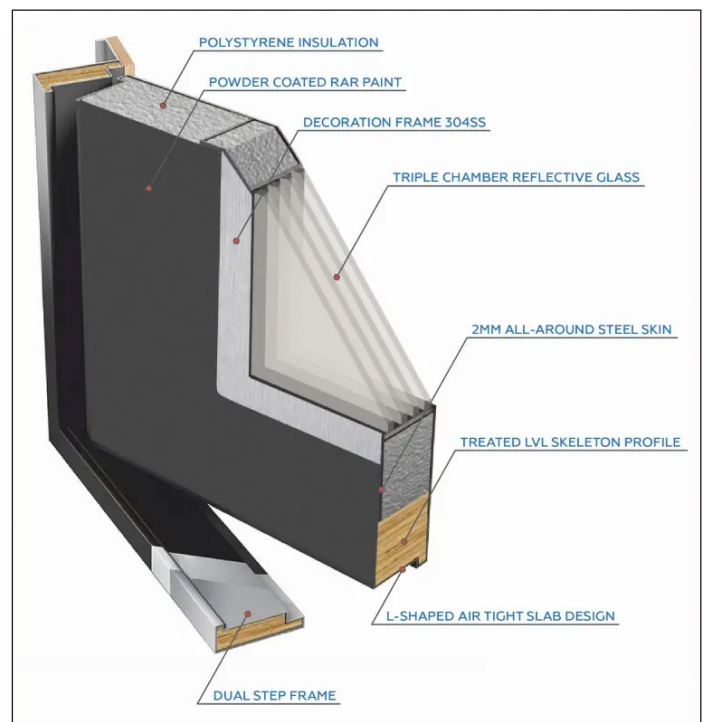



INOX S1 BLACK



INOX S1 BROWN



INOX S1 GRAY



INOX S1 WHITE



INOX S2 BLACK



INOX S2 BROWN



INOX S2 GRAY



INOX S2 WHITE



INOX S3 BLACK



INOX S3 BROWN



INOX S3 GRAY



INOX S3 WHITE





Available Configuration



SINGLE DOOR



LEFT SIDELIGHT



RIGHT SIDELIGHT



DOUBLE SIDELIGHTS



TRANSOM



LEFT SIDELIGHT & TRANSOM



RIGHT SIDELIGHT & TRANSOM



BOTH SIDELIGHTS AND TRANSOM



DOUBLE



DOUBLE W/ LEFT SIDELIGHT



DOUBLE W/ RIGHT SIDELIGHT



DOUBLE W/ BOTH SIDELIGHTS



DOUBLE W/ TRANSOME



DOUBLE W/ LEFT SIDELIGHT AND TRANSOME



DOUBLE W/ RIGHT SIDELIGHT AND TRANSOME



DOUBLE W/ BOTH SIDELIGHTS AND TRANSOME



Royal Series Wrought Iron Entry Doors

- Made of heavy 12 gauge steel.
- Hinged glass option allowing easy access for cleaning and ventilating.
- Mosquito screen option.
- Window lock controls the opening and closing of glass frame.
- Polyurethane foam layer adds insulation from the heat or the cold.
- All thresholds are hand- forged and fully-welded.
- All of our doors undergo a unique seven-step process: Sandblast, Zinc-coat, anti-corrosive prime, middle coat, top coat, faux finish, clear coat.
- Rubber weatherstripping is installed around the door frame and around the interior glass frame.
- Door sweep is installed underneath the door.
- Up and down extension ball latches are installed on all doors.
- On the lower half of the window, there is a small decline for water to run-off.
- All doors come with a standard deadbolt lock.
- Any size or custom design available.

Glass Option

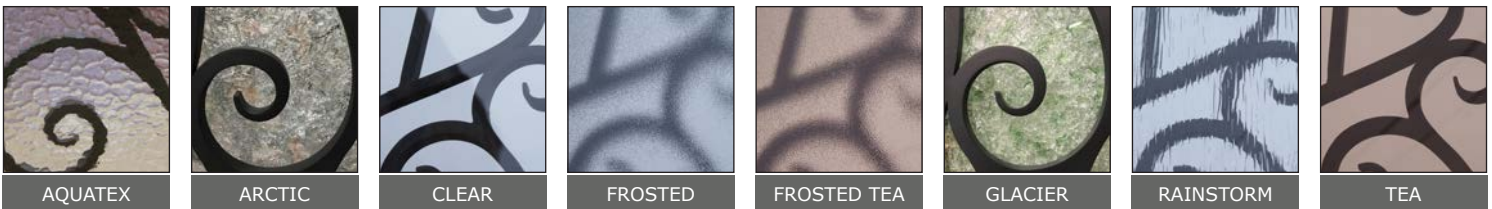

AQUATEX

ARCTIC

CLEAR

FROSTED

FROSTED TEA

GLACIER

RAINSTORM

TEA

Door Finish Option



BLACK

BRONZE

COPPER

ICE CRACKED BRONZE

ICE CRACKED GREY

VEINED IRON GREY

ROYAL SERIES WROUGHT IRON ENTRY DOORS



ROYAL 001



ROYAL 002



ROYAL 003



ROYAL 004



ROYAL 005



ROYAL 006



ROYAL 007



ROYAL 008



ROYAL 009



ROYAL 010



ROYAL 011



ROYAL 012



ROYAL 013



ROYAL 014



ROYAL 015

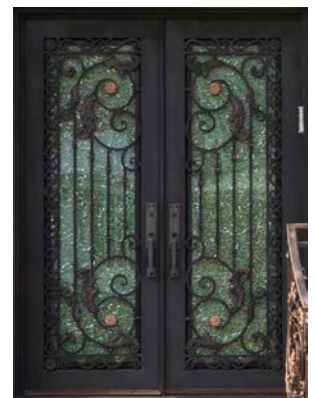

ROYAL 016



ROYAL 017



ROYAL 018



ROYAL 019



ROYAL 020



ROYAL 021



ROYAL 022



ROYAL 023



ROYAL 024



ROYAL 026



ROYAL 027



ROYAL 028



ROYAL 029



ROYAL 030



ROYAL 031



ROYAL 032



ROYAL 033



ROYAL 034



ROYAL 035



ROYAL 036



ROYAL 037



ROYAL 038



ROYAL 039



ROYAL 040



ROYAL 041



ROYAL 042



ROYAL 043



ROYAL 044



ROYAL 045



ROYAL 046



ROYAL 047



ROYAL 048



ROYAL 049



ROYAL 050



ROYAL 051



ROYAL 052





ROYAL 053



ROYAL 054



ROYAL 055



SD-S1

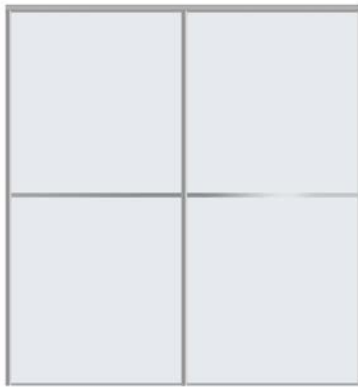

SD-S2



SD-S3

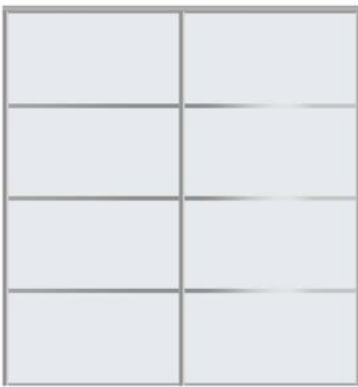

SD-S4

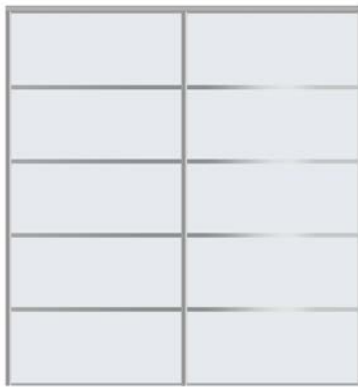

SD-S5

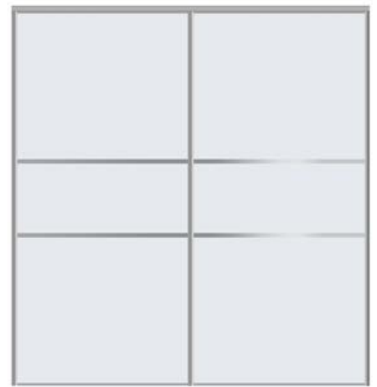

SD-S6

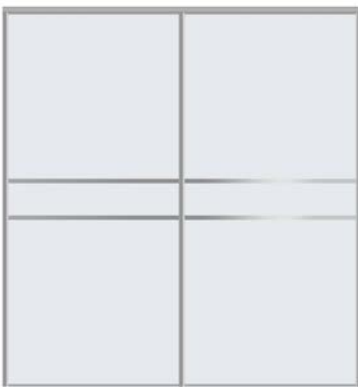

SD-S7

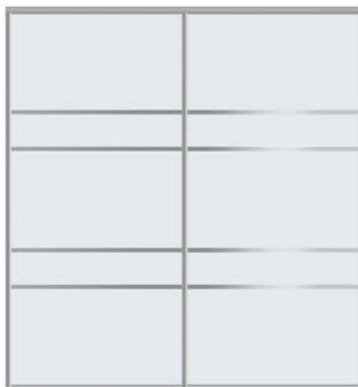

SD-S8



SD-S9

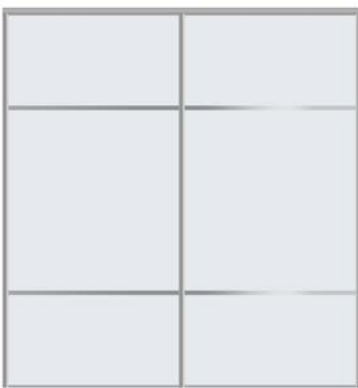

SD-S10



SD-S11

All doors are proudly made in the USA with a sleek premium German aluminum profile, available in 3 colors - Black, Silver and White.

Eleven premade design options can be personalized with any color of glass, mirror, or wood panel. Have something else in mind? Draw your own design and get doors custom-made for you. Custom height or width available.



BD-S1



BD-S2



BD-S3



BD-S4



BD-S5



BD-S6



BD-S7



BD-S8



BD-S9



BD-S10



BD-S11

BI-FOLD DOORS POSSIBLE CONFIGURATIONS



LEFT TO RIGHT

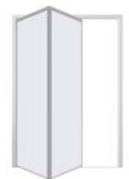

RIGHT TO LEFT

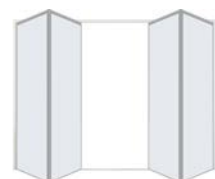

DOUBLE



PD-S1



PD-S2



PD-S3



PD-S4



PD-S5



PD-S6



PD-S7



PD-S8



PD-S9



PD-S10



PD-S11

PIVOT DOORS POSSIBLE CONFIGURATIONS



LEFT TO RIGHT



RIGHT TO LEFT



DOUBLE



SD-13



SD-14



SD-15



SD-16



SD-17



SD-18



SD-19



SD-20



SD-21



SD-22



SD-23

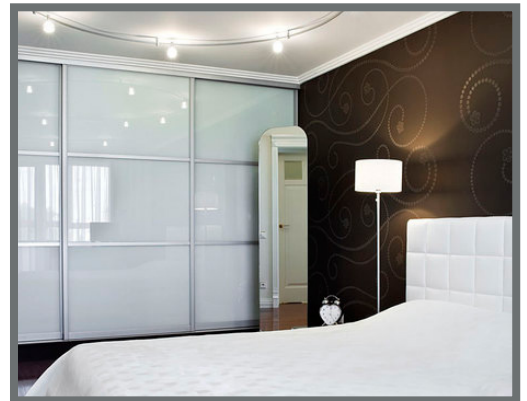

SD-24

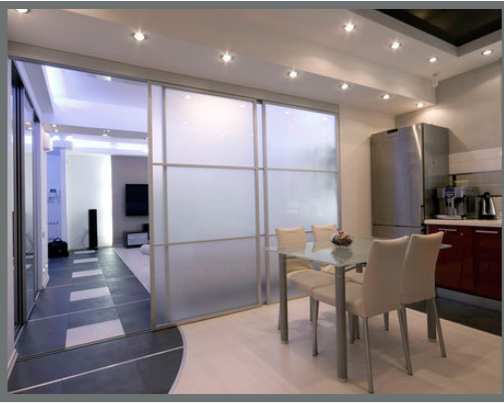

SD-25



SD-26



SD-27



SD-28



SD-29



SD-30



SD-31



SD-32



SD-33

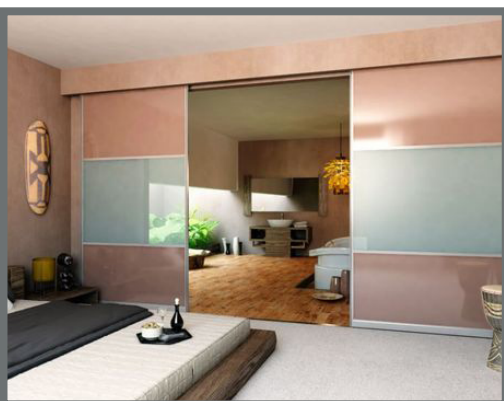

SD-34



SD-35



SD-36



SD-37



SD-38



SD-39



SD-40



SD-41



SD-42



SD-43

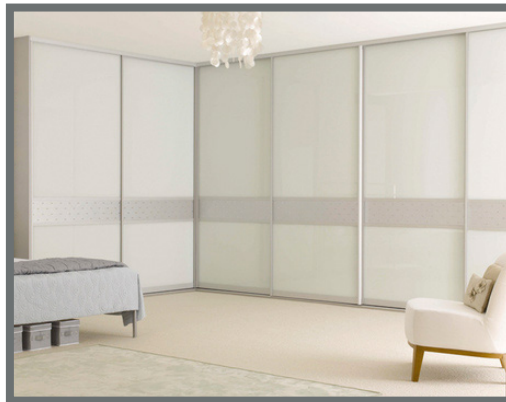

SD-44



SD-45

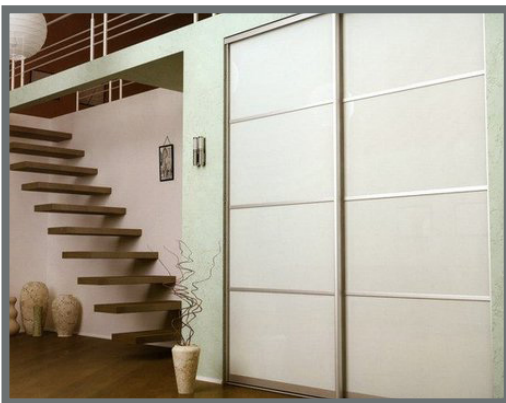

SD-46



SD-47

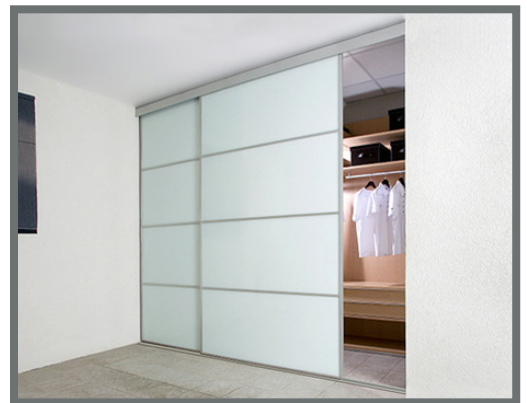

SD-48



SD-49



SD-50



SD-51



SD-52



SD-53



SD-54

AVAILABLE PROFILE FINISHES



SILVER

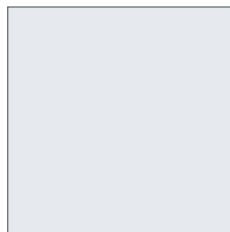

WHITE



BLACK

AVAILABLE GLASS FINISHES

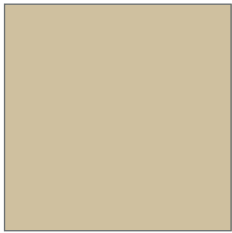

BEIGE



BLACK



BROWN



BURGUNDY



PINK



GREEN



SILVER GREY

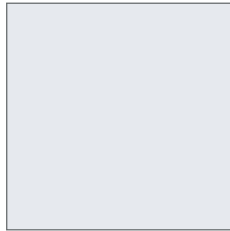

WHITE



LIGHT RED



MIRROR

AVAILABLE PANEL FINISHES



LIGHT ALOE WOOD



LIGHT GREY



PRESTIGE BROWN



SWISS ELM

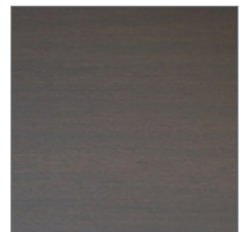

JAPAN OAK

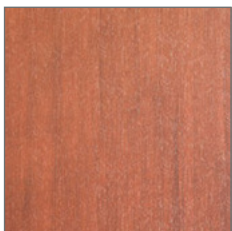

KOREAN MAHOGANY



PURE WHITE

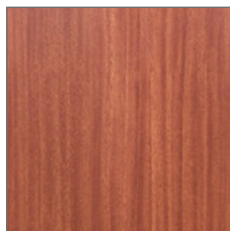

SAPELE

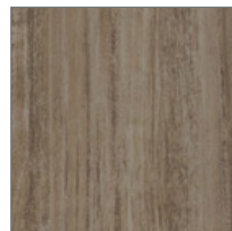

DARK ALOE WOOD



BLACK WALNUT



PREMIUM WENGE

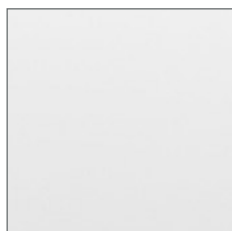

WHITE DRAWING



BLACK ASH



WHITE WENGE

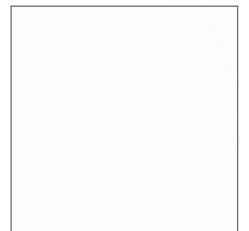

SOFT WHITE

US Standard Hardware



MODERNUS



CURVE



SIMPLICITY



VENUS



SATURN



GRANATA



JUPITER



QUAD

European Hardware



AQUILA

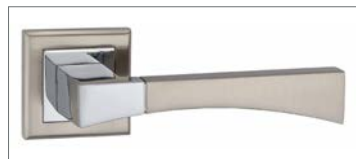

ARIES



DIAMOND



QUATRA



AURORA



LYRA



VEGA



VELA



QUAD BLACK



QUAD WHITE



ORION

SLIDING • BI-FOLD • BYPASS

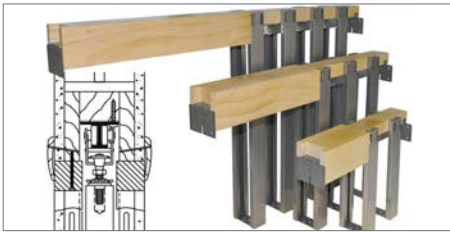

POCKET DOOR FRAME KITS



BI-FOLD DOOR HARDWARE



MULTI FOLD DOOR HARDWARE

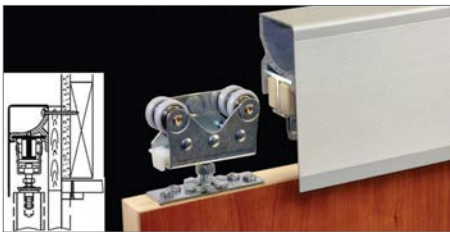

WALL MOUNT SLIDING HARDWARE



SLIDING BYPASS HARDWARE



MULTI-PASS HARDWARE

Smart Sweep Door Hardware

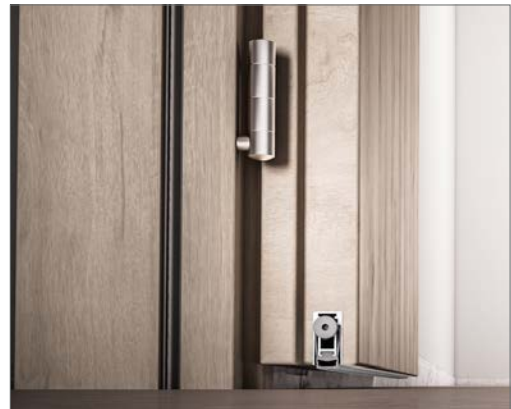
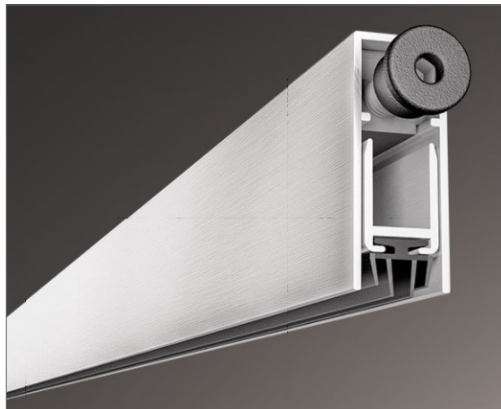

Barn Door Hardware



COUNTRY STYLE



MODERN WITH ROUND TRACK



MODERN WITH T-STYLE TRACK



Magic Sliding Door System

Invisible Sliding System for Wooden and Glass Doors



Interior Door Core Variation

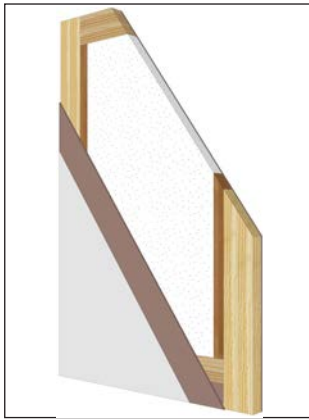

Solid Wood Skeleton with
MDF and Styrofoam

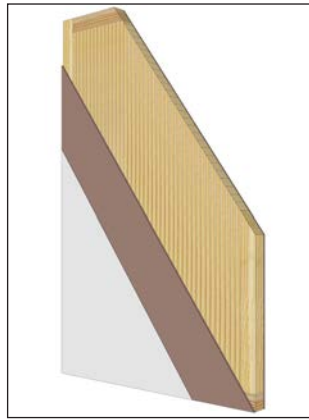

Solid Wood Skeleton with
Solid Wood Strips Core

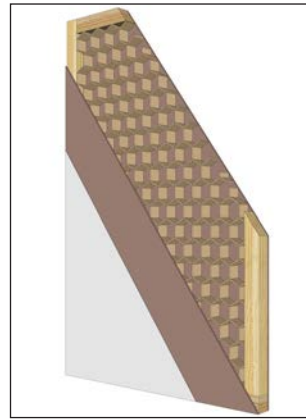

Solid Wood Skeleton with
Honeycomb Core

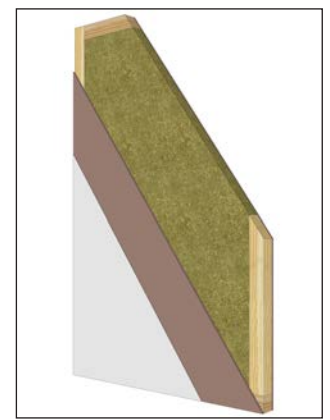

Solid Wood Skeleton with High
Density Filler (Smart CORE)

Jambs - Casings - Extensions

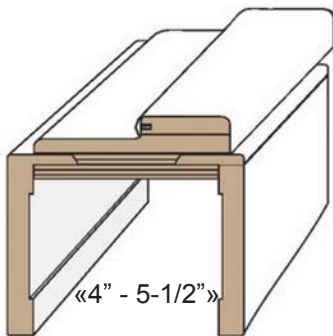

Single Rabbet Telescopic Jamb with
Rubber Seal and L-Shaped Casing on
Both Sides. Extension is Optional.

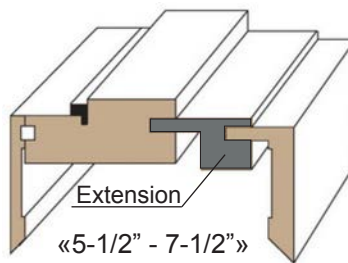

Jamb Extension to Accomodate Any
Width of the Wall.

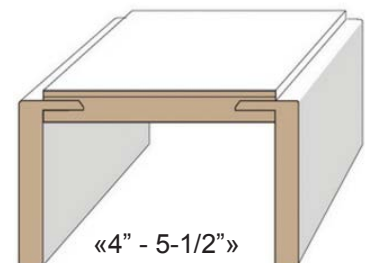

Sliding Door Jambs with Telescopic L-
Shaped Casings. Extension is Optional.

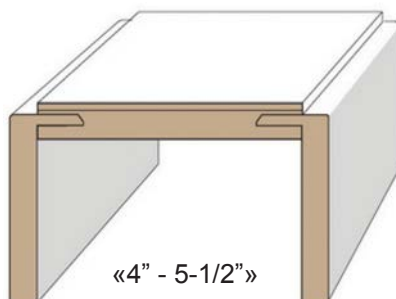

Pocket Door Jambs with Telescopic L-Shaped Casings. Extension is Optional.

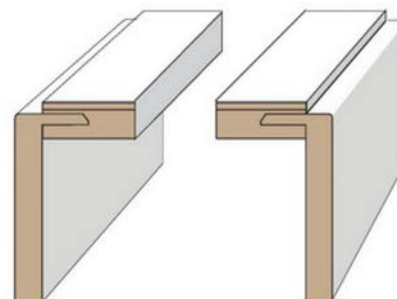

* Matching Baseboards Available.

Door Finish

- Primed - Coating that needs to be painted on site.
- Enamel Paint - 2 part paint process, thicker and more durable than traditional paint.
- PVC - Durable Laminated Coating.
- PPL - Scratch resistant, thicker finish available in textured options.
- Unfinished - Complete unfinished surface, needs to be primed, painted or stained.
- Wood Species - Natural wood to be stained (recommended).
- Wood Veneer - Available in unfinished and pre finished configuration.
- Fiber Glass - Man made material used for exterior doors.
- Steel - Steel doors made for exterior use.

Slab Only Configuration

No Hinge or Handle / No Deadbolt Prep / No Frame / No Casings

- For use in existing frames or for sliding, bypass, pocket, barn or magic option.
- Keep in mind if installing into existing frames every manufacturer has different actual slab sizes. Some are prefit anywhere from 1/8 - 3/4 inches.
- Most Interior Doors Come In 3 Thicknesses 1-3/8", 1-1/2" and 1-3/4"

Knock Down Configuration

- Includes Door Slab, Frame and Casing Set
- Hardware is Optional (We recommend Butterfly Non-Mortise Hinges)
- No Hinge Prep, No Bore Prep
- For DIY Installation



Pre-Hung Configuration

- Prepped and Assembled
- Most Popular Choice For Both Home Owners And Installers
- Faster and Easier Installation Process
- Door Slab is Pre-Cut For Hardware
- Door Is Installed on Frame Using Chosen Hardware
- Casings Cut On Site By Installer To Ensure Proper Fit

US Standard Pre-Hung

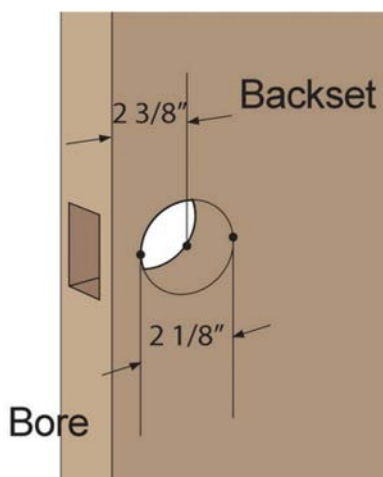

American Hole Bore:

- 2-3/8" Bore Backset is Standard.
- 2-3/4" Bore Backset Upon Request.
- Hung on Ball Bearing Mortise Hinges 3.5" x 3.5" x 5/8" Radius
- 3 Hinges for Doors up to 84 inches
- 4 Hinges for Doors over 84 inches
- Finish: Black, Brushed Satin Nickel, Polished Chrome, Polished Gold, Satin Gold



European Standard Pre-Hung

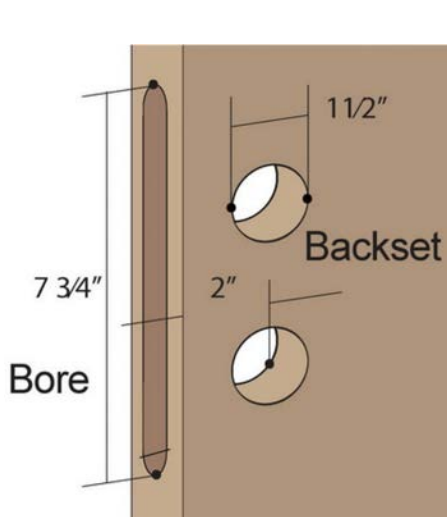

- Hung on European Invisible Hinges.
- Sleek Modern Look as Hinges are not Visible.
- Hinges are Adjustable and Easy to Rectify any Issues After Installation.
- 2 Hinges for Doors up to 84 inches
- 3 Hinges for Doors over 84 inches
- European Magnetick Lock prepped and installed.
- Passage, Privacy or Keyed Function with Round or Square Trim Option.
- Smooth Operation.
- Slimmed European Trim



Invisible 3D Hinges and US Lock Bore Pre-Hung

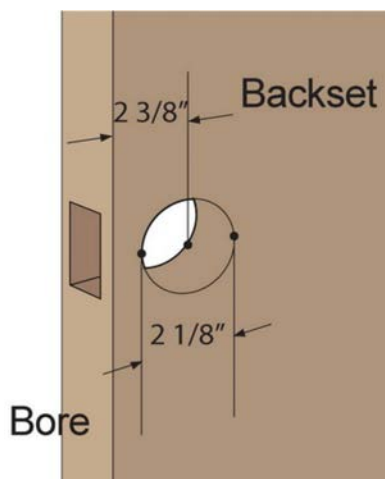

- Hung on European Invisible Hinges.
- Sleek Modern Look as Hinges are not Visible.
- Hinges are Adjustable and Easy to Rectify any Issues After Installation.
- 2 Hinges for Doors up to 84 inches.
- 3 Hinges for Doors over 84 inches.

American Hole Bore:

- 2-3/8" Bore Backset is Standard.
- 2-3/4" Bore Backset Upon Request.



European Lock Bore with Standard Hinges Pre-Hung

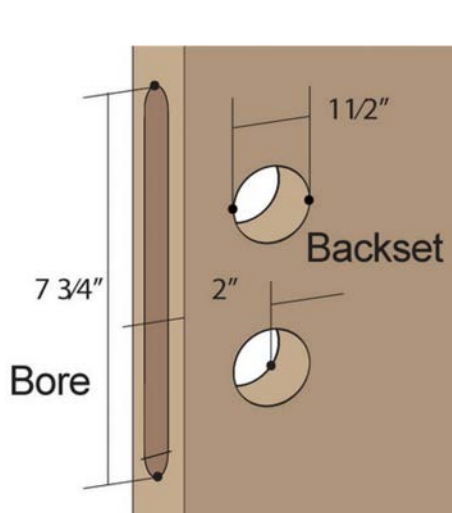

- Hung on Ball Bearing Mortise Hinges 3.5" x 3.5" x 5/8" Radius
- 3 Hinges for Doors up to 84 inches
- 4 Hinges for Doors over 84 inches
- Finish: Satin Nickel, Black, Gold, Chrome
- European Magnetick Lock prepped and installed.
- Passage, Privacy or Keyed Function with Round or Square Trim Option.
- Smooth Operation.
- Slimmed European Trim

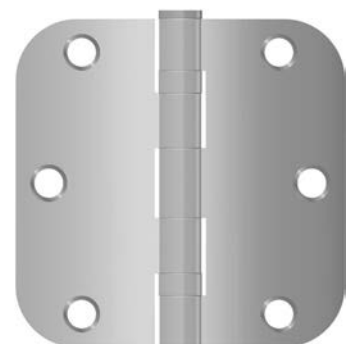

Necessary Tools

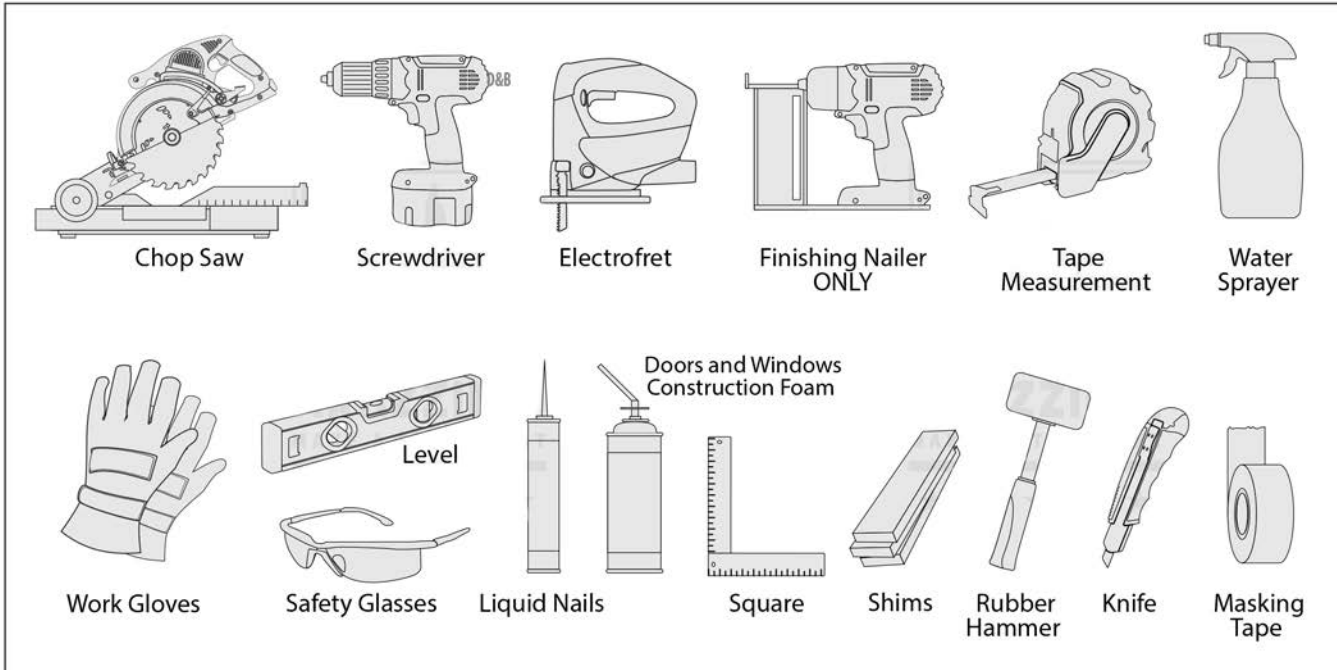

Door Parts

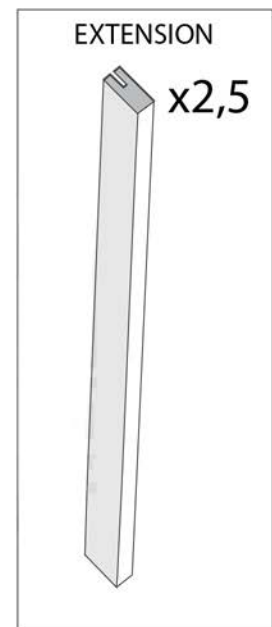
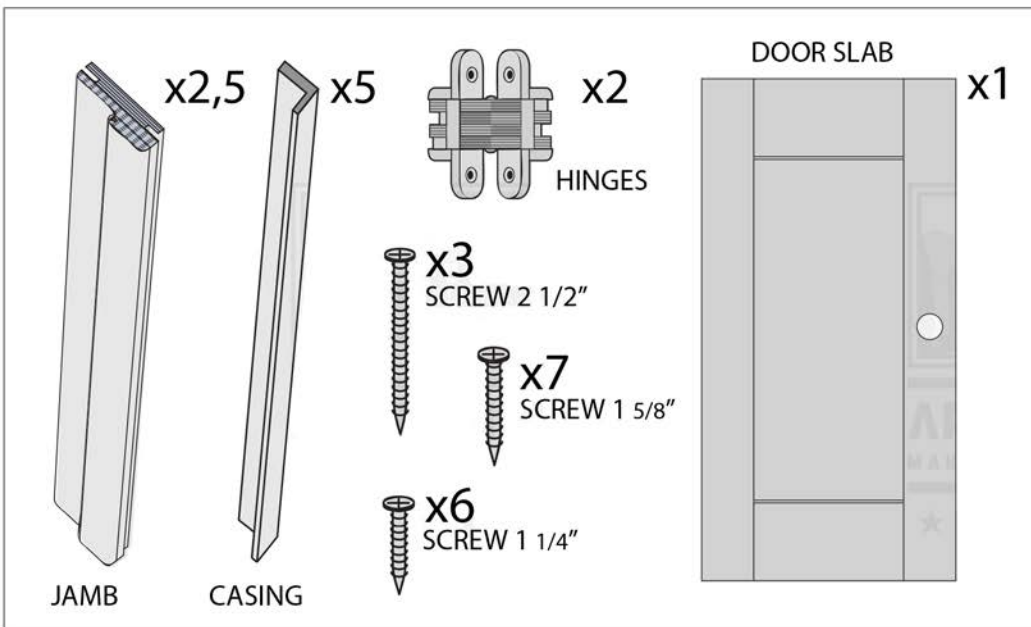

WARNING!

DO NOT USE STANDARD NAILS AND HAMMER

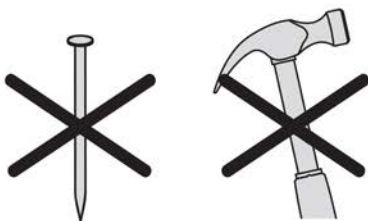

DO NOT STEP ON THE DOOR

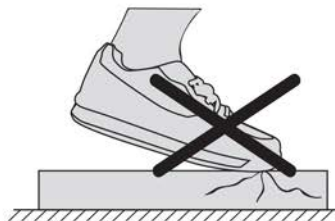

DO NOT LAY DOWN ON EDGES

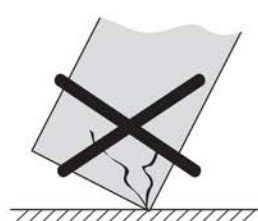

DO NOT LEAN ON THE WALL

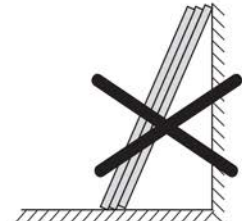

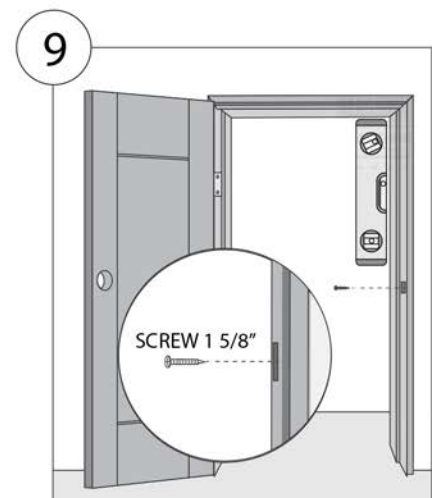
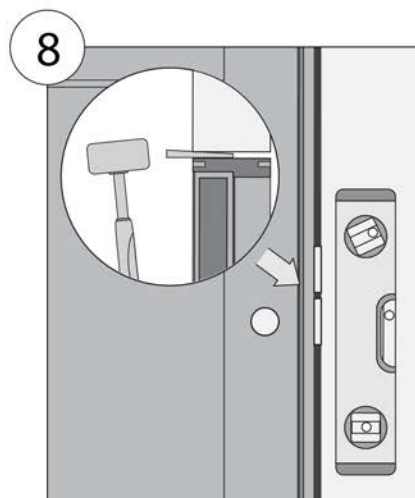
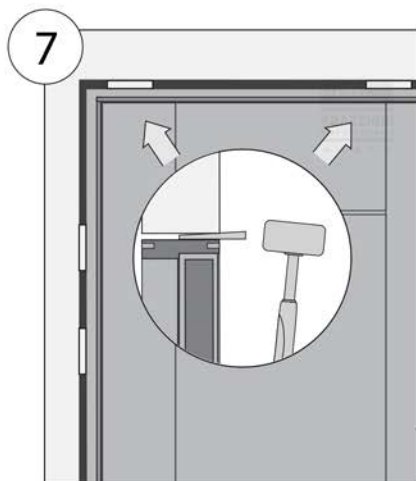
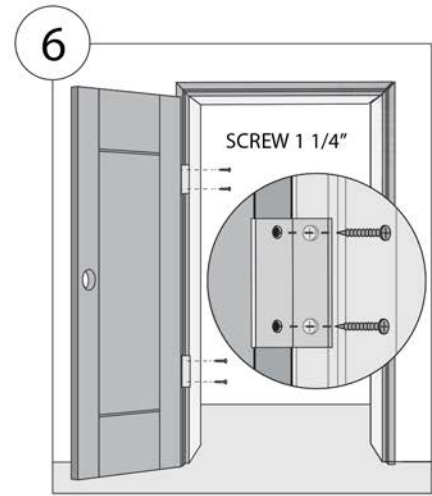
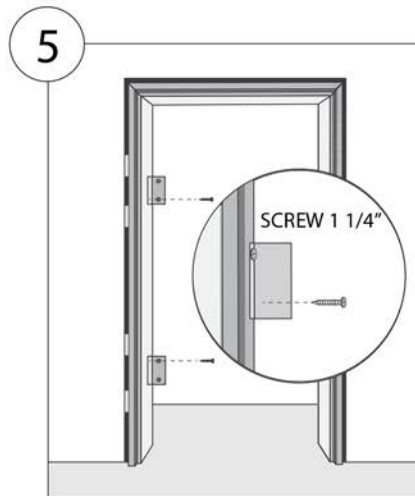
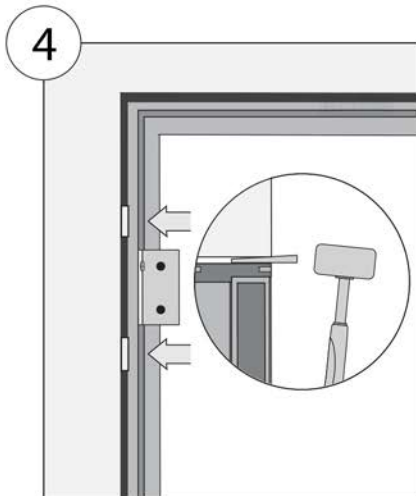
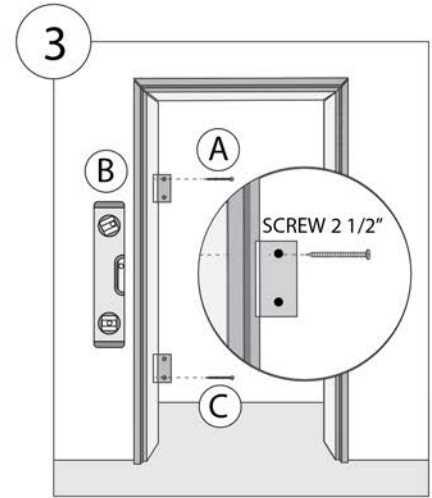
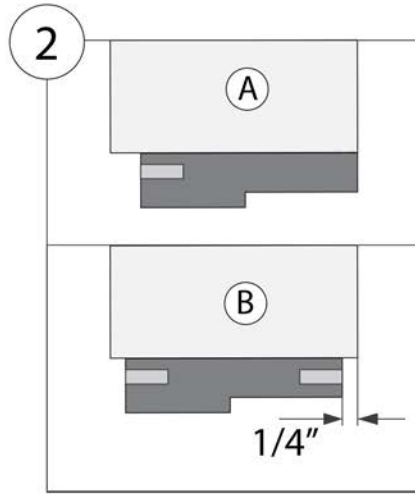
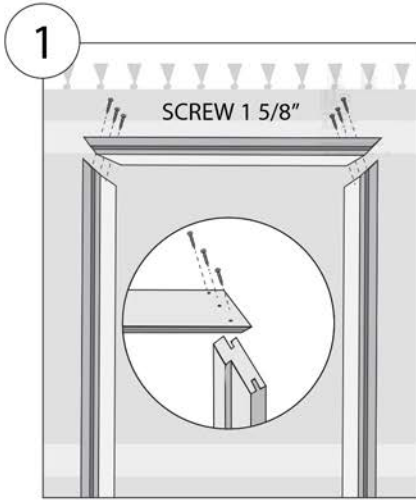

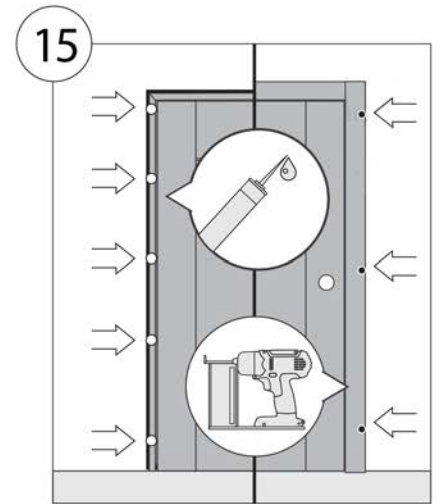
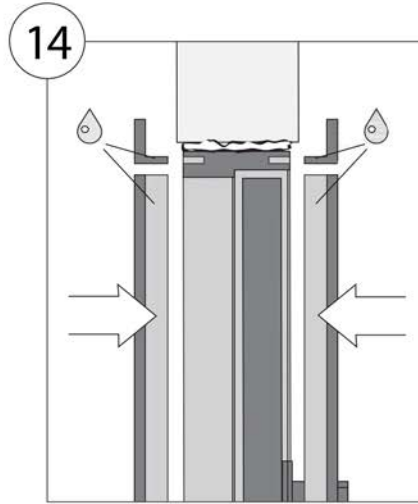
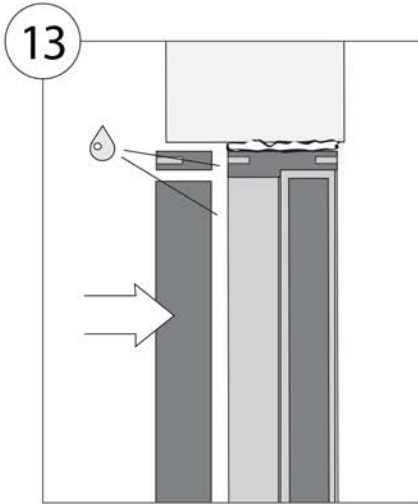
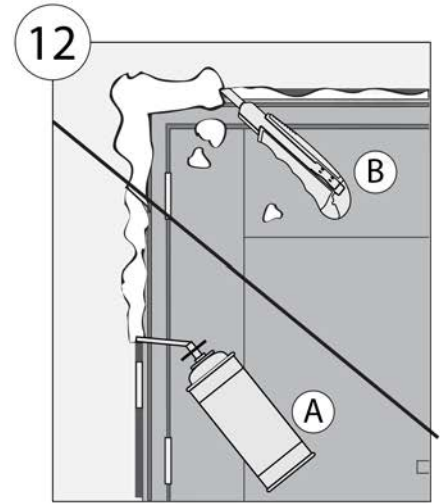
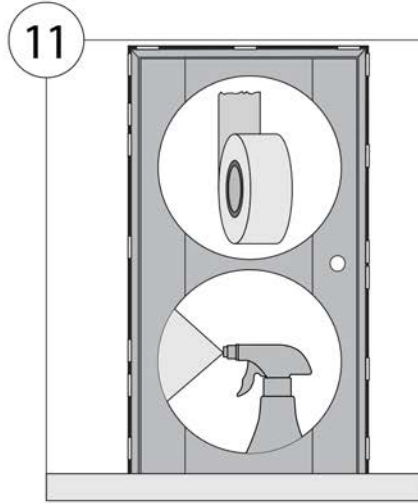
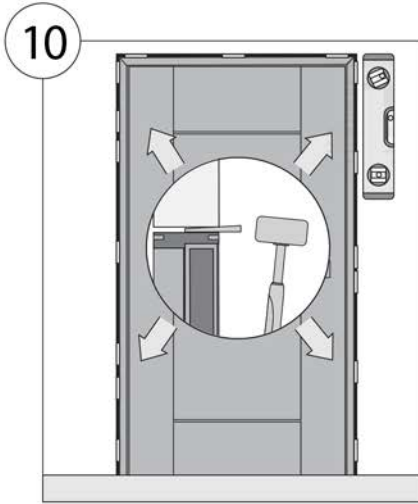

Congratulations
Installation Complete!

NOTES

STANDARD INTERIOR DOOR SIZES
18" 24" 28" 30" 32" 36"
STANDARD OPENINGS
20" 26" 30" 32" 34" 38"

SWING DIRECTIONS

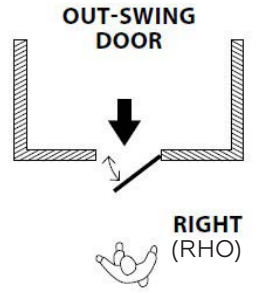
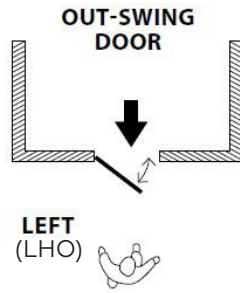
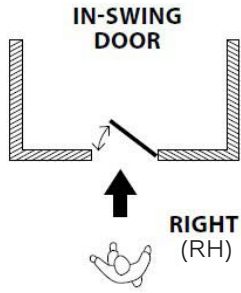
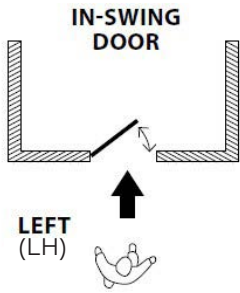

INTERIOR DOOR POSSIBLE CONFIGURATION



SINGLE



DOUBLE



POCKET



DOUBLE POCKET



BI-FOLD



BYPASS



MAGIC



BARN



409 JOYCE KILMER AVE, UNIT 5B
NEW BRUNSWICK, NJ 08901

WWW.NOVADOORSANDHARDWARE.COM

HAVE A QUESTION?
NOVA NICK IS HERE TO HELP

718.414.6181

